

PRICE LIST
C20-21-0117

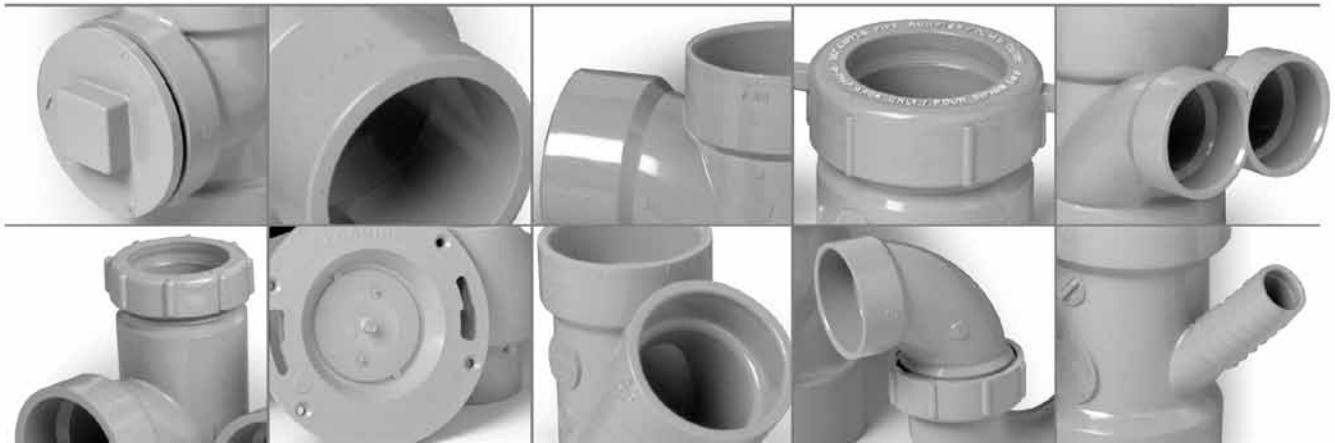

canplas[®]

PVC DWV FITTINGS



JANUARY 2, 2017
SUPERSEDES C20-21-0116 (JANUARY 4, 2016)

Our website pricing is the current list price and may vary from our printed price list.
Please visit our website for up-to-date information.

www.canplasplumbing.com 1-800-461-5300

PVC DWV FITTINGS

PRICE LIST C20-21-0117 JANUARY 2, 2017

TERMS AND CONDITIONS OF SALE

1. General

Except where otherwise agreed to in writing by Canplas all sales are subject to the following terms and conditions. Canplas reserves the right to modify these terms and conditions at its discretion and without notice.

2. Prices

All prices quoted or published are F.O.B. Canplas' factory or authorized warehouse. Published prices are subject to change without notice until orders are accepted by the issuance of an order confirmation. Canplas may agree in writing to protect prices for an extended period of time for specific projects or quotations. Orders may be shipped in whole or in part at Canplas' discretion and will be immediately invoiced upon shipment. Any and all sales, manufacturers' taxes and/or other charges levied or imposed by any governmental authority, foreign or domestic, upon any merchandise sold or contracted to be sold shall be paid by the purchaser and added to the purchase price unless satisfactory and appropriate tax exception certificates are supplied to the Seller.

3. Payment Terms

Unless other terms of payment are agreed to in writing by Canplas or otherwise indicated on specific published price lists, payment is due upon delivery of the products. If applicable, cash discounts, expressed as a percentage, are calculated on the net invoiced prices before any taxes, freight or other charges and can only be deducted from payment if Canplas receives payment from the purchaser on or prior to the due date. Interest shall be charged at a rate of 1.5% per month equating to an annual rate of 18% on all overdue accounts. The granting of credit by Canplas is based on its evaluation of the purchaser's financial condition. If such financial condition does not justify continuance of shipment on credit, Canplas may require full or partial payment in advance.

4. Orders

Purchaser's orders are conditional upon satisfactory credit approval by Canplas. Minimum order values shall be as published in the applicable price list or as agreed to in writing by Canplas. Once confirmed by Canplas, orders for custom made products manufactured to the Purchaser's specifications and orders for large quantities of non-inventoried products cannot be cancelled, modified or returned, without the written consent of Canplas.

5. Shipments

All shipments are F.O.B. Canplas' factory or authorized warehouse. Quoted delivery schedules or those contained in an order acknowledgement are approximate only. Shipment will be made within reasonable proximity to the quoted delivery schedule. Prepaid orders will be shipped via the most economical method at the discretion of Canplas. Should the customer select an alternative method with a higher rate, the difference will be charged to the customer.

6. Shipping Responsibility

Canplas' responsibility ceases when the carrier signs for the shipment in good order. Under no circumstances will Canplas be responsible for any damage caused by delays in shipment, whether resulting from causes within or beyond the control of Canplas. Canplas shall bear no liability for products lost or damaged during transit. Canplas is not responsible for loss or damage to goods in transit, or delays or carriers in delivering shipments or for damages resulting from such delays as those caused by fire, explosion, act of God, strike or other difference with workmen, shortage of material or labor, delays in transportation, government restrictions, war, riot, civil commotion or cause beyond our control. Where shortage or damage is apparent, details should be noted by the carrier on the freight bill at the time of delivery. In case of concealed damage, carrier should be called at once to inspect the damaged shipment. Do not return damaged goods.

7. Returned Goods

Prior to returning any products for any reason the purchaser must obtain a Returned Goods Authorization (RGA) form from Canplas which must accompany the goods being returned. For returned goods that are acceptable for credit, a restocking charge of twenty-five percent (25%) will be assessed against the credit to cover handling, inspection and/or repackaging. Products must be returned freight prepaid, unless otherwise authorized by Canplas. Products must be received in good saleable condition and, if required, in full carton quantities and in their original packaging. Canplas reserves the right to refuse the return of certain products, such as custom-made configurations, obsolete products, excessive quantities or other specialty products. Canplas may, at its discretion, direct that products be destroyed for credit rather than returned.

8. Product Modifications

Canplas reserves the right to make changes or improvements to its products in its sole discretion and without assuming any further obligation.

9. Force Majeure

Canplas shall not be responsible or liable for any non-performance or delay in performance hereunder or any loss or damage of any kind whatsoever, direct or indirect, suffered by the purchaser, subsequent purchasers, ultimate users of the goods or any other person, as a result of any causes beyond the reasonable control of Canplas including, without limitation, price alterations, delay in shipments, strikes, lock-outs, fires, floods, civil commotion, riots, wars, acts of God, embargos, labor shortages, walk-outs, work slowdowns, accidents, breakdowns, delays in manufacture, transportation or delivery of goods or materials, shortages of materials or supplies or government acts or regulations.

10. Miscellaneous

Product names used in Canplas published documents, electronic or printed, are for identification purposes only. All trademarks registered or otherwise, are the property of their respective owners.

11. Governing Law

This agreement and all associated rights and obligations shall be governed by the laws of the province of Ontario and all actions commenced pursuant hereto shall be brought in a court of jurisdiction residing in the province of Ontario.

12. Warranty

Canplas products are carefully inspected for manufacturing defects, however, it is not always possible to detect hidden defects. Unless otherwise specifically stated in writing, Canplas products are warranted only to the extent that Canplas will replace without charge, products proven to have manufacturing defects within 6 months of the date of delivery thereof and provided Canplas has been given an opportunity to inspect the product alleged to be defective and the installation or use thereof. NO WARRANTY IS INCLUDED AGAINST ANY EXPENSE FOR REMOVAL, REINSTALLATION OR OTHER CONSEQUENTIAL DAMAGES ARISING FROM ANY DEFECT. THE WARRANTIES SET OUT ABOVE ARE THE ONLY WARRANTIES MADE BY SELLER AND ARE EXPRESSLY IN LIEU OF ALL OTHER WARRANTIES, EXPRESSED OR IMPLIED, INCLUDING THE WARRANTIES OF MERCHANTABILITY AND FITNESS FOR A PARTICULAR PURPOSE.

TABLE OF CONTENTS Page

Tees	3
Cleanouts	3
Cleanout Plugs	4
Adapters	4
Cleanout Adapters	4
90° Elbows	4
90° Closet Elbows	5
60° Elbows	5
45° Elbows	5
22-1/2° Elbows	5
Wyes	5
Bushings	6
Adapter Bushings	6
Couplings	6
Adapter Couplings	6
Cast Iron Adapters	6
Expansion Joints	8
P Traps	8
Trap Adapters	10
One Piece Closet Flanges	11
Adjustable Closet Flanges	11
45° Closet Flanges	11
Closet Flange Accessories	11
Grates	11
Urinal Flanges	12
Caps	13
Test Plates	13
Index	14

PRODUCT WARNING

DO NOT USE oil based putty or pipe joint compounds with an ABS products. It will cause cracking and breakage of the ABS products over time

ALL IMAGES ARE FOR REPRESENTATIVE PURPOSES. ACTUAL PRODUCT MAY VARY IN FORMAT THAT SHOWN.

PVC DWV FITTINGS

PRICE LIST C20-21-0117 **JANUARY 2, 2017**

DESC.	PART #	SKID QTY.	CTN. QTY.	SIZE	PRICE EACH
-------	--------	-----------	-----------	------	------------

TEES

SANITARY TEE - H x H x H



202151	2880	90	1½	9.23
202152	1440	45	2	16.96
202128	1680	35	2 x 1½ x 1½	13.80
202127	1800	25	2 x 1½ x 2	21.32
202126	1600	50	2 x 2 x 1½	13.46
202153	360	20	3	37.33
202131	800	25	3 x 3 x 1½	26.46
202130	640	20	3 x 3 x 2	28.94
202154	216	12	4	67.67
202134	360	15	4 x 4 x 2	67.23
202136	270	15	4 x 4 x 3	80.40
202144	90	5	6 x 6 x 4	294.54
202156	72	3	6 x 6 x 6	247.87

SANITARY TEE, Street - Spg x H x H



205154	216	12	4	72.52
205131	800	25	3 x 3 x 1½	34.56

SANITARY TEE, with Left Side Inlet - H x H x H x H



202147L	320	10	3 x 3 x 3 x 1½	67.62
202148L	320	10	3 x 3 x 3 x 2	77.65

SANITARY TEE, with Right Side Inlet - H x H x H x H



202147R	320	10	3 x 3 x 3 x 1½	67.62
202148R	320	10	3 x 3 x 3 x 2	77.65

DOUBLE SANITARY TEE - H x H x H x H



202187	1080	15	1½	23.42
202186	720	10	2	35.26
202188	960	20	2 x 2 x 1½ x 1½	40.09
202184	240	5	3	55.75
202189	480	15	3 x 3 x 1½ x 1½	48.76
202181	480	15	3 x 3 x 2 x 2	50.84
202185	144	8	4	219.78

DESC.	PART #	SKID QTY.	CTN. QTY.	SIZE	PRICE EACH
-------	--------	-----------	-----------	------	------------

HORIZONTAL TWIN TEE



203750	480	15	3x3x1½x1½	178.47
--------	-----	----	-----------	--------



► material

- Injection molded in ABS (Black) and PVC (Grey).

► function

- To provide two 1½" connections to a 3" tee on the same side.

► features

- 3" tee with two side by side 1½" sanitary hub connections.
- Compact design.

► benefits

- Eliminates the need to stack two 3" x 1½" tees on top of each other, avoiding complicated installations.
- Perfect application for back to back fixtures such as sinks and bathtubs.

► approvals

- The Horizontal Twin Tee meets ASTM D2468 and D1784 standards. IAPMO and CSA approval pending.

PVC DWV FITTINGS

PRICE LIST C20-21-0117 **JANUARY 2, 2017**

DESC.	PART #	SKID QTY.	CTN. QTY.	SIZE	PRICE EACH
-------	--------	-----------	-----------	------	------------

CLEANOUTS

CLEANOUT TEE with Plug & O-ring - H x H



202114A	2400	50	1½	23.13
202115A	1440	45	2	37.19
202116A	480	15	3	63.20
202117A	240	10	4	113.76
202118A	72	4	6	384.37

REDUCING LINE CLEANOUT with Plug & O-ring - H x H

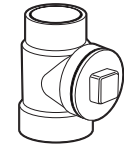

202107A	270	15	4 x 3 x 4	107.97
---------	-----	----	-----------	---------------

CLEANOUT PLUGS

CLEANOUT PLUG - MPT



203051	14400	100	1½	6.49
203052	10800	150	2	7.98
203053	2520	35	3	11.59
203054	1800	25	4	22.58

ADAPTERS

MALE ADAPTER - MPT x H



202860	-	0	1¼ x 1½	7.71
202871	9000	125	1½	4.96
202872	5760	80	2	10.72
202873	2160	30	3	20.53
202874	1080	15	4	54.54
202876	240	5	6	157.56

FEMALE ADAPTER - H x FPT

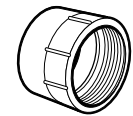

202891	7200	100	1½	6.05
202892	5400	75	2	10.72
202893	1440	30	3	21.24
202894	800	25	4	48.48

DESC.	PART #	SKID QTY.	CTN. QTY.	SIZE	PRICE EACH
-------	--------	-----------	-----------	------	------------

CLEANOUT ADAPTERS

FITTING CLEANOUT ADAPTER, with Plug - Spg x FPT

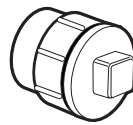

203701A	6480	90	1½	13.24
203702A	4320	60	2	19.83
203703A	1440	30	3	31.01
203704A	800	25	4	62.94
203706A	288	12	6	227.72

FITTING CLEANOUT ADAPTER - Spg x FPT

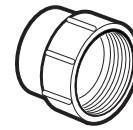

203701-1	-	100	1½	6.88
203702-1	-	60	2	12.94
203703-1	-	35	3	20.81
203704-1	-	25	4	34.56
203706-1	-	15	6	159.18

TUBE END CLEANOUT, with Plug & O-ring - H x FPT

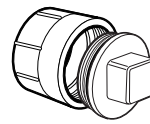

202891A	6480	90	1½	13.91
202892A	3600	50	2	19.83
202893A	1440	30	3	36.49
202894A	640	20	4	71.05

90° ELBOWS

1/4 BEND (90°) - H x H

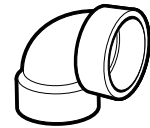

202251	4000	125	1½	6.60
202252	2400	50	2	9.66
202253	640	20	3	27.27
202254	320	10	4	45.96
202256	72	4	6	204.69
202258	32	1	8	464.18

1/4 BEND (90°), LONG TURN - H x H

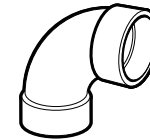

202251L	3520	110	1½	8.22
202252L	1600	50	2	9.66
202253L	480	15	3	27.27
202254L	270	15	4	45.96

1/4 BEND, Street (90°), LONG TURN - Spg x H

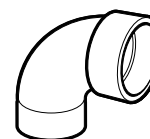

202451	4000	125	1½	6.60
202452	2400	50	2	13.46
202453	640	20	3	30.01
202453L	480	15	3	30.01
202454	270	15	4	45.96
202454L	270	15	4	76.83
202456	72	4	6	208.75

PVC DWV FITTINGS

PRICE LIST C20-21-0117 **JANUARY 2, 2017**

DESC.	PART #	SKID QTY.	CTN. QTY.	SIZE	PRICE EACH
-------	--------	-----------	-----------	------	------------

90° ELBOWS Continued

1/4 BEND (90°), LONG SWEEP - H x H

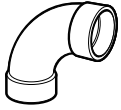

202277	1440	45	2		25.32
--------	------	----	---	--	-------

90° CLOSET ELBOWS

CLOSET BEND, Reducing - H x H

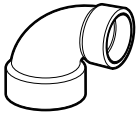

202223	360	20	4 x 3		67.47
--------	-----	----	-------	--	-------

60° ELBOWS

1/6 BEND (60°) - H x H

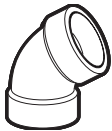

202601	3600	50	1½		12.16
202602	2160	30	2		15.69
202603	640	20	3		36.22
202604	320	10	4		68.01

45° ELBOWS

1/8 BEND (45°), SHORT TURN - H x H

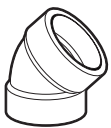

202521	6000	125	1½		5.23
202522	3600	50	2		8.22
202523	800	25	3		23.00
202524	450	25	4		40.38
202506	144	8	6		172.67
202528	48	1	8		350.73

1/8 BEND, Street (45°), SHORT TURN - Spg x H



202421	6000	125	1½		5.23
202422	3600	50	2		9.92
202423	800	25	3		24.38
202424	450	25	4		40.38
202406	144	8	6		172.67

DESC.	PART #	SKID QTY.	CTN. QTY.	SIZE	PRICE EACH
-------	--------	-----------	-----------	------	------------

22-1/2° ELBOWS

1/16 BEND (22½°) - H x H



202551	5400	75	1½		7.71
202552	2400	50	2		14.04
202553	960	20	3		31.82
202554	480	15	4		54.62
202556	144	8	6		299.37

WYES

WYE - H x H x H



202301	2240	70	1½		11.02
202302	1280	40	2		20.23
202303	360	20	3		42.40
202304	216	12	4		67.53
202306	36	2	6		220.01
202324	1200	25	2 x 1½ x 1½		19.83
202325	1800	25	2 x 2 x 1½		19.04
202331	640	20	3 x 3 x 1½		30.01
202326	640	20	3 x 3 x 2		33.32
202328	288	16	4 x 4 x 2		62.40
202327	240	10	4 x 4 x 3		61.27
202343	72	4	6 x 6 x 3		311.05
202344	72	4	6 x 6 x 4		204.69
202307	24	1	8 x 8 x 4		386.43
202309	24	1	8 x 8 x 6		386.43
202308	12	1	8		421.78

WYE, Street - Spg x H x H



205303	360	20	3		79.59
--------	-----	----	---	--	-------

DOUBLE WYE - H x H x H x H



202351	960	30	1½		27.27
202352	640	20	2		42.70
202374	720	10	2 x 2 x 1½ x 1½		36.37
202353	-	5	3		79.59
202377	360	15	3 x 3 x 2 x 2		67.23
202381	144	8	4 x 4 x 3 x 3		198.00

DOUBLE WYE, Street - Spg x H x H x H



205376	320	10	3 x 3 x 1½ x 1½		132.22
--------	-----	----	-----------------	--	--------

PVC DWV FITTINGS

PRICE LIST C20-21-0117 **JANUARY 2, 2017**

DESC.	PART #	SKID QTY.	CTN. QTY.	SIZE	PRICE EACH
-------	--------	-----------	-----------	------	------------

BUSHINGS

FLUSH BUSHING - Spg x H

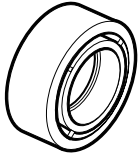

202752	10800	150	2 x 1½	4.43
202762	2520	35	3 x 1½	19.67
202754	2880	60	3 x 2	14.32
202758	1440	20	4 x 2	27.60
202756	1680	35	4 x 3	29.23
202767	384	12	6 x 4	133.06
202770	48	1	8 x 4	178.23
202769	48	1	8 x 6	208.88

FLUSH BUSHING - Spg x FPT

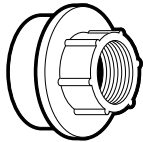

202747††	17280	120	1½ x ½	9.66
202749††	14400	100	1½ x ¾	12.67

†† Can be used for either dishwasher or condensate connections when combined with thread x barb nipple

ADAPTER BUSHINGS

ADAPTER BUSHING - (Adapts DWV Hub to Sewer & Drain Spigot) Spg x H

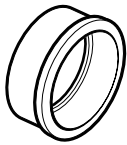

202841	3600	50	3	11.02
202842	1600	50	4	12.39
202846	450	25	6	19.67

COUPLINGS

COUPLING - H x H



203001	9000	125	1½	3.72
203002	4800	100	2	5.51
203003	1440	45	3	12.84
203004	800	25	4	22.16
203006	216	12	6	115.97
203008	48	1	8	168.00

REDUCER COUPLING - H x H



203022	5400	75	2 x 1½	8.53
203023	2520	35	3 x 1½	19.98
203024	2520	35	3 x 2	19.98
203029	960	20	4 x 1½	29.30
203025	960	20	4 x 2	29.30
203026	960	30	4 x 3	30.16
203037	288	12	6 x 4	212.17

DESC.	PART #	SKID QTY.	CTN. QTY.	SIZE	PRICE EACH
-------	--------	-----------	-----------	------	------------

ADAPTER COUPLINGS

ADAPTER COUPLING (Adapts Sewer & Drain to DWV) - H x H

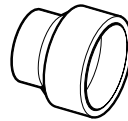

203035	360	20	6 x 4	228.04
--------	-----	----	-------	--------

CAST IRON ADAPTERS

NO HUB ADAPTER, Cast Iron (Adapts No Hub Elastomer Coupling to DWV Spigot) - H x Spg

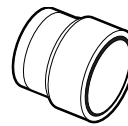

203420	7200	100	1½	18.51
203422	3600	50	2	27.56
203423	2160	30	3	31.12
203424	1080	15	4	44.87

Visit our website
for more
information

- Specification Sheets
- E-Newsletter
- Price Lists



www.canplasplumbing.com

Now Mobile Friendly
Try from your tablet or smart phone.

canplas®

Appliance / Dishwasher Wye

For roughing in or installing a dishwasher, water softener or any appliance with a 1/2" or 3/4" discharge hose.

Features

- Injection molded in ABS (Black) and PVC (Grey).
- Top and bottom sockets are 1 1/2" DWV (Schedule 40) size.
- Branch arm is a 1/2" or 3/4" hose barb.
- Unit comes complete with molded on plug.
- Plug will hold test without solvent cementing.
- Saves time and money.
- CSA certified
- NSF, IAPMO listed

Installation



Single sink installation.

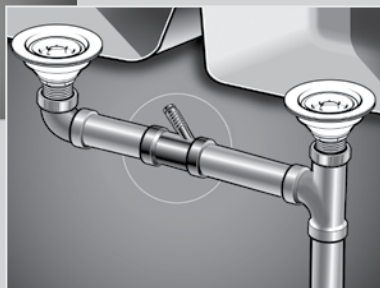

Double sink installation.

- For rough-in, insert plug into hose barb. When installing an appliance, simply remove plug and attach hose.
- Plug has oversized top to prevent installation of hose with plug still in place.
- Can be installed vertically or horizontally.



DESC.	PART #	SKID QTY.	CTN. QTY.	SIZE	PRICE EACH
-------	--------	-----------	-----------	------	------------

APPLIANCE WYE/GREYTRAP TRAP PRIMER
- H x H x Hose Barb
Snap-in Plug is Molded on Fitting for Use During "Rough-In"

	212321	2880	40	1½ x 1½ x ½	11.71
---	--------	------	----	-------------	--------------

Alternative use as greywater trap primer

The greywater trap primer port fitting used the head of water in the p-trap, to allow a small amount of water to flow through the primer hose, ensuring the connected floor drain trap seal is maintained.

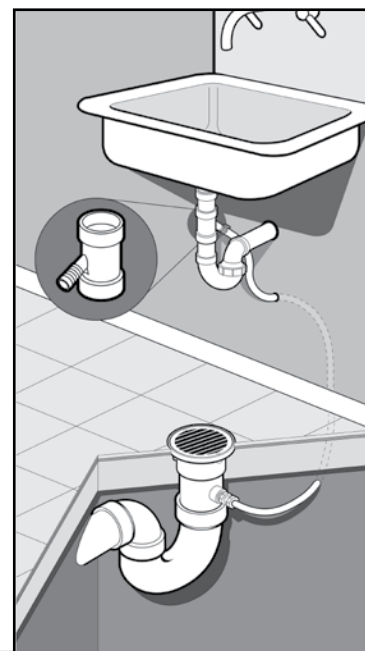

PVC DWV FITTINGS

PRICE LIST C20-21-0117 **JANUARY 2, 2017**

DESC.	PART #	SKID QTY.	CTN. QTY.	SIZE	PRICE EACH
-------	--------	-----------	-----------	------	------------

EXPANSION JOINTS

Exclusively from canplas

Allows for the expansion and contraction of pipe due to temperature change and the shrinkage of building materials that the pipe is connected to.

Approvals

- CSA Certified, IAPMO Listed
- Approved for use in vertical applications

Type I H x H Type I H x Spg Type II H x H

EXPANSION JOINT - H x H

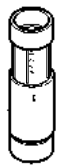

TYPE I - 3" Travel

213811ABC	1728	12	1½	74.96
213812ABC	1080	15	2	107.23
213813ABC	480	15	3	168.16

TYPE II - 8" Travel

213814ABC	128	4	4	273.08
-----------	-----	---	---	---------------

EXPANSION JOINT - H x Spg End Piston



TYPE I - 3" Travel

213811BBC	1728	12	1½	80.40
213812BBC	1080	15	2	115.12
213813BBC	480	15	3	180.67

P TRAPS

P TRAP, with Solvent Weld Joint - H x H

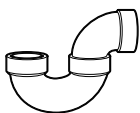

203201	1280	40	1½	18.57
203202	640	20	2	41.86
203203	180	10	3	101.90
203204	108	6	4	193.34

P TRAP, with Cleanout & Solvent Weld Joint - H x H



203201A	1120	35	1½	21.87
203202A	640	20	2	57.17

DESC.	PART #	SKID QTY.	CTN. QTY.	SIZE	PRICE EACH
-------	--------	-----------	-----------	------	------------

P TRAPS Continued

P TRAP, with Cleanout & Union Connection - H x H

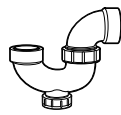

203211A	1120	35	1½	24.65
---------	------	----	----	--------------

P TRAP U-Bend - H x H

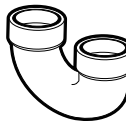

203203-1	-	10	3	82.22
203206-1	48	2	6	876.74

P TRAP, with Union - H x H

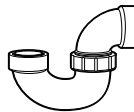

203211E	1280	40	1½	21.06
203212E	640	20	2	48.08

GREY WATER TRAP PRIMER - H x H x Hose



212321	2880	40	1½ x 1½ x ½	11.71
--------	------	----	-------------	--------------

Grey Water Installation

The grey water trap primer port fitting used the head of water in the p-trap, to allow a small amount of water to flow through the primer hose, ensuring the connected floor drain trap seal is maintained.

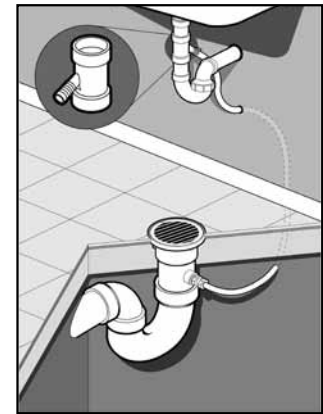

POLYETHYLENE GASKET for PermOseal® P Trap



103231-6	72000	500	-	3.90
----------	-------	-----	---	-------------

PVC DWV FITTINGS

PRICE LIST C20-21-0117 JANUARY 2, 2017



PermOseal

Kitchen and Bathroom P-Traps



Material

Available in ABS (Black) and PVC (Grey) with or without cleanout.

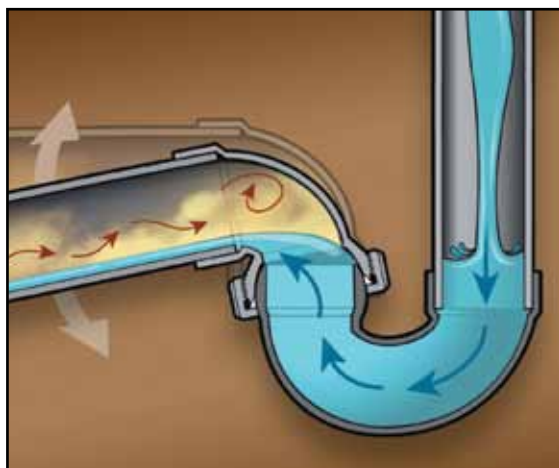

Connection

Adjustable joint allows up to 10° of angle adjustment providing ease of installation in situations with pipe misalignment or offset fittings while maintaining a secure seal.

Exclusively from **canplas**

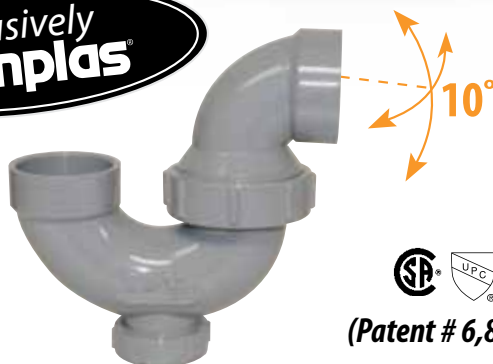

(Patent # 6,859,956)

DESC.	PART #	SKID QTY.	CTN. QTY.	SIZE	PRICE EACH
PERMOSEAL® P TRAP with Union Connection & Cleanout - H x H					
	203231A	1120	35	1½	27.02

PERMOSEAL® P TRAP, with Union Connection - H x H					
	203231E	1120	35	1½	23.13

PVC DWV FITTINGS

PRICE LIST C20-21-0117 **JANUARY 2, 2017**

DESC.	PART #	SKID QTY.	CTN. QTY.	SIZE	PRICE EACH
-------	--------	-----------	-----------	------	------------

TRAP ADAPTERS

SANITARY TEE TRAP ADAPTER - H x H x Slip Joint

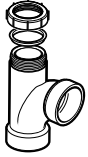

212171A	1600	50	1½	42.62
---------	------	----	----	-------

90° TRAP ADAPTER - H x Slip Joint, Ideal for Pedestal Sinks



212281A	3600	50	1½ x 1½	23.25
---------	------	----	---------	-------

TRAP ADAPTER, with Washer & Nut - H x Slip

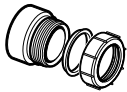

202851A	7200	100	1½	10.18
202860A	7200	100	1½ x 1¼	10.59

FITTING TRAP ADAPTER, with Washer & Nut - Spg x Slip

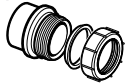

202801A	7200	100	1½	10.72
203211Y	7200	100	1½ x 1¼	11.14

FITTING TRAP ADAPTER, less Washer & Nut (Fitting Male Adapter) - Spg x MPT



202801	-	1	1½	4.61
--------	---	---	----	------

COPPER TO DWV PIPE ADAPTER - H x Slip



202861A	5760	80	1½	19.83
202864A††	5760	80	1½ x 1¼	20.81

†† CSA certified for use in P Trap area only

90° SINK STRAINER ADAPTER H x Strainer Adapter (with Gasket)



212291A	3600	50	1½	26.25
---------	------	----	----	-------

SWIVEL TRAY PLUG (STRAINER) ADAPTER, with Washer H x FPT



203217	7200	100	1½	19.12
--------	------	-----	----	-------

DESC.	PART #	SKID QTY.	CTN. QTY.	SIZE	PRICE EACH
-------	--------	-----------	-----------	------	------------

TRAP ADAPTERS Continued

SLIP JOINT NUT



203931	-	700	1½	3.56
--------	---	-----	----	------

SLIP JOINT WASHER



109210-003	72000	1000	1¼	3.56
109210-004	57600	800	1½	3.67
109210-005	7200	400	2	5.90

Visit our website
for more
information

- Specification Sheets
- E-Newsletter
- Price Lists

www.canplasplumbing.com

Now Mobile Friendly
Try from your tablet or smart phone.



PVC DWV FITTINGS

PRICE LIST C20-21-0117 **JANUARY 2, 2017**

DESC.	PART #	SKID QTY.	CTN. QTY.	SIZE	PRICE EACH
-------	--------	-----------	-----------	------	------------

ONE PIECE CLOSET FLANGES

CLOSET FLANGE, One Piece Plastic - Hub End with Gussets

	203634	800	25	4 x 3	29.30
--	---------------	------------	-----------	--------------	--------------

CLOSET FLANGE, One Piece Plastic - With Molded Test Plate

	203634T	800	25	4 x 3	38.43
--	----------------	------------	-----------	--------------	--------------

CLOSET FLANGE, One Piece Plastic - Hub

	Flush Fit	203631††	800	25	4 x 3	36.22
--	-----------	-----------------	------------	-----------	--------------	--------------

	With Molded Test Plate	203631T††	800	25	4 x 3	38.70
--	------------------------	------------------	------------	-----------	--------------	--------------

†† Fits over 3" or inside 4" Schedule 40 DWV pipe

1/2" OVERALL - Spg

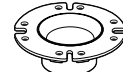
	203634-7	800	25	4 x 3	35.67
---	-----------------	------------	-----------	--------------	--------------



WARNING

Canplas recommends sponge rubber and wax gaskets only for use with all closet flanges.

DESC.	PART #	SKID QTY.	CTN. QTY.	SIZE	PRICE EACH
-------	--------	-----------	-----------	------	------------

ADJUSTABLE CLOSET FLANGES

CLOSET FLANGE, Adjustable

	Hub End, with Adjustable Plastic Ring	203624	800	25	4 x 3	46.62
---	---------------------------------------	---------------	------------	-----------	--------------	--------------

	Spigot End with Adjustable Plastic Ring	203626	800	25	4 x 3	55.08
---	---	---------------	------------	-----------	--------------	--------------

	Hub End, with Molded Test Plate	203624T	800	25	4 x 3	50.84
---	---------------------------------	----------------	------------	-----------	--------------	--------------

	Spigot End, with Molded Test Plate	203626T	800	25	4 x 3	56.85
---	------------------------------------	----------------	------------	-----------	--------------	--------------

45° CLOSET FLANGES

45° DISCHARGE CLOSET FLANGE - Hub

	With Adjustable Plastic Ring	213628	640	20	4 x 3	124.60
---	------------------------------	---------------	------------	-----------	--------------	---------------

CLOSET FLANGE ACCESSORIES

CLOSET FLANGE SPACER RING WITH 4 HOLES

	219180-002	3600	25	4 x 3	19.67
---	-------------------	-------------	-----------	--------------	--------------

GRATES

DRAIN GRATE - Spg

	203864	1800	25	4	28.10
---	---------------	-------------	-----------	----------	--------------

PVC DWV FITTINGS

PRICE LIST C20-21-0117 JANUARY 2, 2017



Used to provide a seal between 2" internally trapped urinals and drainage system.

canplas®

Urinal Flange Kits

- Flanges are made of corrosion resistant ABS and PVC plastic. They will not rot out like traditional urinal flanges providing longer life and fewer health concerns.
- 2" connections available in Hub and Spigot versions making Canplas urinal flange kits adaptable to a variety of systems.
- Complete with all the necessary mounting hardware eliminating missing or back-ordered parts.
- Available in 4" center models and adjustable 4" - 7" center models which can be cut easily to accommodate the requirements of most applications.
- The flange is reinforced with a cross rib to prevent the fork from spreading.
- Thick foam gasket provides a positive seal, reducing the potential for leaks.

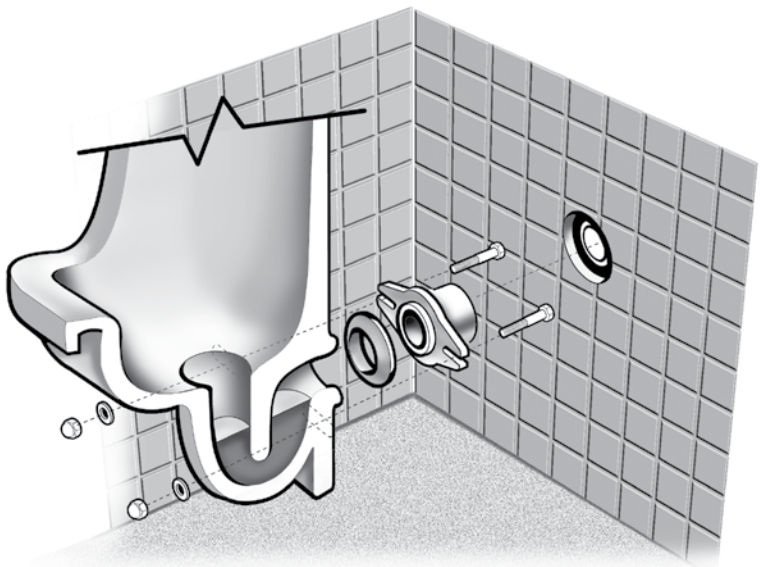

DESC.	PART #	SKID QTY.	CTN. QTY.	SIZE	PRICE EACH
-------	--------	-----------	-----------	------	------------

URINAL FLANGE KIT - PVC - Spigot

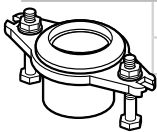

	213660††	1200	25	2	110.23
	213661‡‡	1440	20	2	126.10

URINAL FLANGE KIT - PVC - Hub

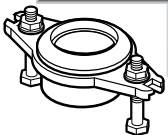

	213662††	1800	25	2	110.23
	213663‡‡	1440	20	2	126.10

†† with 4" Center ‡‡ with Adjustable Center: 4" - 7"

PVC DWV FITTINGS

PRICE LIST C20-21-0117 **JANUARY 2, 2017**

DESC.	PART #	SKID QTY.	CTN. QTY.	SIZE	PRICE EACH
-------	--------	-----------	-----------	------	------------

CAPS

CAP - Hub



203081	14400	100	1½	11.42
203082	7920	110	2	19.04
203083	2160	30	3	34.01
203084	1200	25	4	35.67
203086	384	12	6	117.76
203088	-	1	8	190.60

POLYETHYLENE CAP Slip-on Style - Orange



10TC314	18000	125	1¼	10.21
10TC315	14400	200	1½	6.49
10TC316	10800	150	2	12.04
10TC318	2520	35	3	15.80
10TC320	1920	40	4	22.12
10TC322	480	10	6	56.08

TEST PLATES

TEST PLATE - Spg

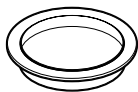

203761	-	100	1½	10.47
203762	-	100	2	11.15
203763	-	100	3	14.04
203764	7200	100	4	17.82

DESC.	PART #	SKID QTY.	CTN. QTY.	SIZE	PRICE EACH
-------	--------	-----------	-----------	------	------------

APPROVALS:

Unless otherwise noted, products are approved / listed by CSA International, NSF and IAPMO to standards that include:

CSA B181.2

NSF Standard 14

IAPMO IS5, PS 146-99

Warnock Hersey CAN/ULC S-102.2

ASTM D2665, D1784, D3311



PVC DWV FITTINGS

INDEX

PRICE LIST C20-21-0117 **JANUARY 2, 2017**

PART#	Weight (Kgs.)	CARTON BARCODE	PG. #	PART#	Weight (Kgs.)	CARTON BARCODE	PG. #	PART#	Weight (Kgs.)	CARTON BARCODE	PG. #
103231-6	0.002	10662671109238	10	202377	0.637	10662671203233	5	203026	0.354	10662671201352	6
109210-003	0.001	10662671108941	10	202381	1.493	10662671200621	5	203029	0.298	10662671201376	6
109210-004	0.001	10662671103236	10	202406	1.463	10662671200676	5	203035	0.832	10662671203790	6
109210-005	0.002	10662671103243	10	202421	0.055	10662671200683	5	203037	0.843	30662671203787	6
10TC314†	0.007	10662671103250	12	202422	0.076	10662671200690	5	203051	0.039	10662671201406	4
10TC315†	0.007	10662671103267	12	202423	0.264	10662671200706	5	203052	0.049	10662671201413	4
10TC316†	0.012	10662671103274	12	202424	0.465	10662671200713	5	203053	0.117	10662671201420	4
10TC318†	0.024	10662671103281	12	202451	0.073	10662671200720	4	203054	0.198	10662671201437	4
10TC320†	0.035	10662671103298	12	202452	0.125	10662671200737	4	203081	0.03	10662671201451	12
10TC322†	0.092	10662671109023	12	202453	0.376	10662671200744	4	203082	0.044	10662671201468	12
202107A	1.026	10662671200010	4	202453L	0.459	10662671200751	4	203083	0.159	10662671201475	12
202114A	0.108	10662671200034	4	202454	0.717	10662671200768	4	203084	0.292	10662671201482	12
202115A	0.188	10662671200041	4	202454L	0.814	10662671200775	4	203086	0.749	10662671202366	12
202116A	0.622	10662671200058	4	202456	2.256	10662671200274	4	203088	1.506	10662671203769	12
202117A	1.037	10662671200065	4	202506	1.489	10662671200829	5	203201	0.194	10662671201505	8
202118A	2.689	10662671202441	4	202521	0.054	10662671200836	5	203201A	0.221	10662671201512	8
202126	0.175	10662671200072	3	202522	0.077	10662671200843	5	203202	0.393	10662671201529	8
202127	0.186	10662671200089	3	202523	0.28	10662671200850	5	203202A	0.388	10662671201994	8
202128	0.165	10662671200096	3	202524	0.511	10662671200867	5	203203	1.19	10662671201536	8
202130	0.39	10662671200102	3	202528	2.904	30662671203480	5	203203-1	0.812	10662671201543	8
202131	0.326	10662671200119	3	202551	0.063	10662671200874	5	203204	1.513	10662671201567	8
202134	0.61	30662671200120	3	202552	0.085	10662671200881	5	203206-1	3.468	10662671202786	8
202136	0.909	10662671200133	3	202553	0.275	10662671200898	5	203211A	0.248	10662671201598	8
202144	1.957	10662671202762	3	202554	0.485	10662671200904	5	203211E	0.212	10662671201604	8
202147L	0.691	10662671200140	3	202556	1.376	10662671200911	5	203211Y	0.051	10662671201628	10
202147R	0.695	10662671200157	3	202601	0.071	10662671200928	5	203212E	0.422	10662671201635	8
202148L	0.702	10662671200164	3	202602	0.109	10662671200935	5	203217	0.049	10662671202038	10
202148R	0.695	10662671200171	3	202603	0.348	10662671200942	5	203231A	0.328	10662671203738	9
202151	0.11	10662671200188	3	202604	0.634	10662671200959	5	203231E	0.295	10662671203745	9
202152	0.179	10662671200195	3	202747	0.046	10662671200966	6	203420	0.046	10662671203172	6
202153	0.567	10662671200201	3	202749	0.038	10662671200973	6	203422	0.081	10662671202045	6
202154	1.091	10662671200218	3	202752	0.039	10662671200997	6	203423	0.189	10662671201659	6
202156	2.755	10662671202687	3	202754	0.14	10662671201000	6	203424	0.285	10662671201666	6
202181	0.505	10662671200232	3	202756	0.178	10662671201017	6	203624	0.335	10662671201710	11
202184	0.822	10662671200249	3	202758	0.256	10662671201024	6	203624T	0.389	10662671201727	11
202185	1.435	10662671200256	3	202762	0.135	10662671201048	6	203626	0.31	10662671201734	11
202186	0.26	10662671200263	3	202767	0.736	10662671201055	6	203626T	0.334	10662671203929	11
202187	0.2	10662671200270	3	202769	1.682	10662671203653	6	203631	0.349	10662671201741	11
202188	0.228	10662671200287	3	202770	1.556	10662671203660	6	203631T	0.37	10662671202076	11
202189	0.402	10662671200294	3	202801	0.04	00662671203984	10	203634	0.359	10662671201758	11
202223	0.6	10662671200300	5	202801A	0.056	10662671201062	10	203634-7	0.31	10662671202281	11
202251	0.078	10662671200317	4	202841	0.053	10662671201086	6	203634T	0.358	10662671201765	11
202251L	0.098	10662671200324	4	202842	0.091	10662671201093	6	203701-1	0.04	10662671202700	4
202252	0.116	10662671200331	4	202846	0.337	10662671202304	6	203701A	0.08	10662671201772	4
202252L	0.128	10662671200348	4	202851A	0.055	10662671201109	10	203702-1	0.05	10662671202694	4
202253	0.414	10662671200355	4	202860	0.04	10662671204032	4	203702A	0.1	10662671201789	4
202253L	0.419	10662671200362	4	202860A	0.053	10662671201116	10	203703-1	0.18	10662671203967	4
202254	0.743	10662671200379	4	202861A	0.086	10662671201123	10	203703A	0.31	10662671201796	4
202254L	0.784	10662671200386	4	202864A	0.083	10662671201130	10	203704-1	0.275	10662671202182	4
202256	2.343	10662671200393	4	202871	0.039	10662671201154	4	203704A	0.473	10662671201802	4
202258	3.632	10662671203554	4	202872	0.048	10662671201161	4	203706-1	0.691	10662671203882	4
202277	0.183	10662671200416	5	202873	0.178	10662671201178	4	203706A	1.014	30662671201813	4
202301	0.127	10662671200430	5	202874	0.262	10662671201185	4	203750	0.418	10662671203387	3
202302	0.189	10662671200447	5	202876	0.737	10662671203677	4	203761	0.004	10662671203608	12
202303	0.655	10662671200454	5	202891	0.051	10662671201192	4	203762	0.008	10662671203844	12
202304	1.158	10662671200461	5	202891A	0.092	10662671202120	4	203763	0.015	10662671203448	12
202306	2.916	10662671200478	5	202892	0.069	10662671201208	4	203764	0.053	10662671203455	12
202307	3.818	10662671203561	5	202892A	0.119	10662671201215	4	203864	0.244	10662671201864	11
202308	6.949	10662671203509	5	202893	0.22	10662671201222	4	203931	0.015	10662671203943	10
202309	4.827	10662671203646	5	202893A	0.353	10662671201239	4	205131	0.315	10662671201871	3
202324	0.163	10662671200485	5	202894	0.358	10662671201246	4	205154	0.976	10662671202014	3
202325	0.172	10662671200492	5	202894A	0.556	10662671203462	4	205303	0.604	10662671201895	5
202326	0.409	10662671200508	5	203001	0.036	10662671201260	6	205376	0.551	10662671203615	5
202327	0.887	10662671200515	5	203002	0.047	10662671201277	6	212171A	0.165	10662671212419	10
202328	0.779	30662671200526	5	203003	0.203	10662671201284	6	212281A	0.095	10662671212150	10
202331	0.368	10662671200539	5	203004	0.331	10662671201291	6	212291A	0.086	10662671212587	10
202343	2.337	10662671203806	5	203006	1.03	10662671201307	6	212321	0.091	10662671211962	7
202344	2.208	10662671200546	5	203008	1.914	10662671203691	6	213628	0.45	10662671211979	11
202351	0.171	10662671200553	5	203022	0.055	10662671201314	6	213660	0.177	10662671212877	13
202352	0.333	10662671200560	5	203023	0.17	10662671201321	6	213661	0.189	10662671212884	13
202353	0.13	10662671200577	5	203024	0.166	10662671201338	6	213662	0.151	10662671213782	13
202374	0.263	10662671200591	5	203025	0.302	10662671201345	6	213663	0.163	10662671213805	13

PVC DWV FITTINGS

PRICE LIST C20-21-0117 **JANUARY 2, 2017**

PART#	Weight (Kgs.)	CARTON BARCODE	PG. #	PART#	Weight (Kgs.)	CARTON BARCODE	PG. #	PART#	Weight (Kgs.)	CARTON BARCODE	PG. #
213811ABC	0.305	30662671202469	8								
213811BBC	0.305	30662671202476	8								
213812ABC	0.364	30662671201820	8								
213812BBC	0.369	30662671201837	8								
213813ABC	0.871	30662671201844	8								
213813BBC	0.875	30662671201851	8								
213814ABC	2.325	30662671202261	8								
219180-002	0.138	10662671212488	11								

PVC DWV FITTINGS



canplas®

Head Office, Manufacturing Location and Customer Service Centre

500 VETERANS DRIVE, BOX 1800
BARRIE, ON L4M 4V3
CANADA

TELEPHONE: (705) 726-3361
FAX: (705) 726-2186
EMAIL: plumbing@canplas.com

Customer Service Centre and Sales Office

9489 - 200 STREET, UNIT 201
LANGLEY, B.C. V1M 3A7
CANADA

TELEPHONE: (604) 455-0432
FAX: (604) 455-0452

Customer Service Centre and Sales Office

11408-163rd STREET
EDMONTON, AB T5M 3T3
CANADA

TELEPHONE: (780) 451-3206
FAX: (780) 452-0536

www.canplasplumbing.com

1-800-461-5300

